

Lieferliste











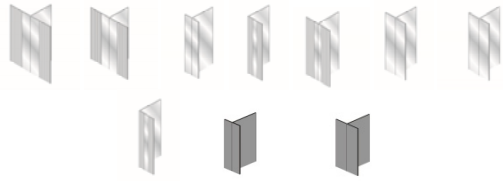







Gültig ab 1. Mai 2023









fischer 
BWM Facade Systems

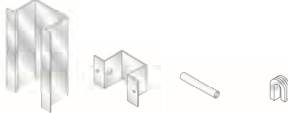

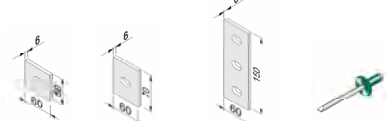



BWM Fassadensysteme
BWM Facade systems

Inhalt

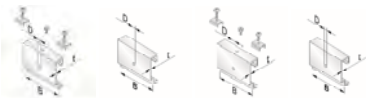
Konstruktion	Artikel		Seite
ATK 100 Minor	Tragprofile blank und schwarz eloxiert		5 - 10
	Clip		11 - 12
ATK 100 KL	Klammern		13 - 14
	Drucklippe, Spezialniet		15
ATK 102 Minor	Tragprofile		16
	EPDM, Klammern, Niete		17 - 19
ZeLa Click	ZeLa Click Aluminium und Edelstahl		20 - 22
ZeLa	ZeLa Aluminium und Edelstahl		23 - 32

Konstruktion	Artikel		Seite
Wandwinkel	Wandwinkel, Haltefedern		33 - 38
	Thermostop für Wandwinkel, Niete, Schrauben, U-Scheiben		39 - 40
FLH R	FLH R Wandhalter Edelstahl		41 - 42
ATK 101	Tragprofile		43
	U-Halter Typ N LW 44 t= 3 und t= 4mm		44 - 51
	Thermostop für U-Halter, Niete		52
ATK 106 SZ 20	Tragprofile, Clip		53
	U-Halter Typ N LW 50 t= 3 und t= 4mm		54 - 59

Konstruktion	Artikel		Seite
ATK 107-B	Profil, Bolzen, Clip		60
	U-Halter Typ N LW 70, Einlegescheiben		61 - 66
	Thermostop, Niete		67
ATK 601	Befestigungssatz mit Grundteil, T-Konsole, Dübel, Niet		68 - 69
Holzhalter	Holzhalter Typ T2		70
ATK 103 S und P	Tragprofile		71
	Agraffen		72 - 73
ATK 103 T	Tragprofile und Agraffen		74

Konstruktion	Artikel		Seite
ATK 103 S-20 und P-20	Tragprofile		75
	Agraffen		76 - 77
ATK 103 EE und EE 20	Agraffen für erleichterten Einbau		78 - 79
ATK 103 V, V -1 und Z-Profil	Tragprofile		80
ATK 103 S-20 T	Tragprofil und Agraffen		81
Zusatzartikel	Brandbarrieren mit Zubehör		82
	AccuBird und Nietsetzlehren		83
Lieferbedingungen innerhalb Deutschland			84

ATK 100 Minor
Tragprofile walzblank



T-Profil 120/52/2		
Material: EN AW 6063 T66		
L [mm]	Artikel-Nr.	
6000	632730	



T-Profil 110/52/2		
Material: EN AW 6063 T66		
L [mm]	Artikel-Nr.	
6000	632713	



T-Profil 100/52/2		
Material: EN AW 6063 T66		
L [mm]	Artikel-Nr.	
6000	632700	



T-Profil 40/52/2		
Material: EN AW 6063 T66		
L [mm]	Artikel-Nr.	
6000	632740	

ATK 100 Minor Tragprofile walzblank



L-Profil 42/50/2		
Material: EN AW 6063 T66		
L [mm]	Artikel-Nr.	
6000	632720	



T-Profil 60/52/2 glatt		
Material: EN AW 6063 T66		
L [mm]	Artikel-Nr.	
6000	632710	



T-Profil 70/52/2		
Material: EN AW 6063 T66		
L [mm]	Artikel-Nr.	
6000	632770	



T-Profil 80/52/2 glatt		
Material: EN AW 6063 T66		
L [mm]	Artikel-Nr.	
6000	632780	



T-Profil 40/50/2 glatt		
Material: EN AW 6063 T66		
L [mm]	Artikel-Nr.	
6000	662740	

ATK 100 Minor Tragprofile walzblank



T-Profil 100/50/2 glatt		
Material: EN AW 6063 T66		
L [mm]	Artikel-Nr.	
6000	662700	

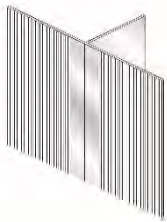

T-Profil 160/52/2		
Material: EN AW 6063 T66		
L [mm]	Artikel-Nr.	
6000	632760	

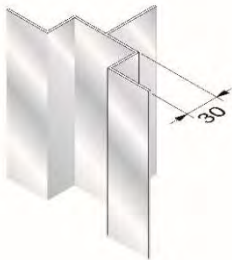

Tulpenprofil 40/28/66/28/40		
Material: EN AW 6063 T66		
L [mm]	Artikel-Nr.	
6000	611267	

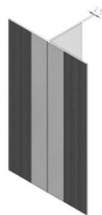

T-Profil 120/52/2 – 2,5mm		
Material: EN AW 6063 T66		
L [mm]	Artikel-Nr.	
6000	632735	

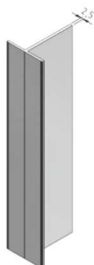

T-Profil 40/52/2 – 2,5mm		
Material: EN AW 6063 T66		
L [mm]	Artikel-Nr.	
6000	632745	

ATK 100 Minor
Tragprofile walzblank



T-Profil 50/32/2-3		
Material: EN AW 6063 T66		
L [mm]	Artikel-Nr.	
6000	632751	

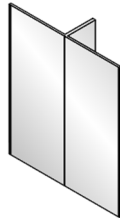

T-Profil 120/32/2-3		
Material: EN AW 6063 T66		
L [mm]	Artikel-Nr.	
6000	632734	

ATK 100 Minor
Tragprofile schwarz eloxiert



T-Profil 120/52/2 schwarz		
Material: EN AW 6063 T66 Oberfläche Eloxal C35		
L [mm]	Artikel-Nr.	
6000	S632731	



T-Profil 110/52/2 schwarz		
Material: EN AW 6063 T66 Oberfläche Eloxal C35		
L [mm]	Artikel-Nr.	
6000	S632713	



T-Profil 100/52/2 schwarz		
Material: EN AW 6063 T66 Oberfläche Eloxal C35		
L [mm]	Artikel-Nr.	
6000	S632737	



T-Profil 60/52/2 schwarz		
Material: EN AW 6063 T66 Oberfläche Eloxal C35		
L [mm]	Artikel-Nr.	
6000	S632711	

ATK 100 Minor Tragprofile schwarz eloxiert



T-Profil 40/52/2 schwarz		
Material: EN AW 6063 T66 Oberfläche Eloxal C35		
L [mm]	Artikel-Nr.	
6000	S632739	

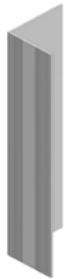

L-Profil 42/50/2 schwarz		
Material: EN AW 6063 T66 Oberfläche Eloxal C35		
L [mm]	Artikel-Nr.	
6000	S632721	



T-Profil 40/52/2,5 schwarz		
Material: EN AW 6063 T66 Oberfläche Eloxal C35		
L [mm]	Artikel-Nr.	
6000	S632749	



T-Profil 120/52/2,5 schwarz		
Material: EN AW 6063 T66 Oberfläche Eloxal C35		
L [mm]	Artikel-Nr.	
6000	S632735	

ATK 100 Minor

Clip 107



Clip (Befestigung von 2mm Material)			
Material: Aluminium			
Breite [mm]	Anzahl Lochungen	Artikel-Nr.	
30	1	68952-2	
40	1	68954-2	
40	2	68953-2	
60	2	68955-2	
80	2	68956-2	
100	2	68958-2	
zur Befestigung von Kassetten und Paneelen andere Breiten und Sonderlochungen auf Anfrage			



Clip (Befestigung von 3mm Material)			
Material: Aluminium			
Breite [mm]	Anzahl Lochungen	Artikel-Nr.	
30	1	68952-3	
40	1	68954-3	
40	2	68953-3	
60	2	68955-3	
80	2	68956-3	
100	2	68958-3	
zur Befestigung von Kassetten und Paneelen andere Breiten und Sonderlochungen auf Anfrage			

ATK 100 Minor

Clip 107



Clip (Befestigung von 4 mm Material)			
Material: Aluminium			
Breite [mm]	Anzahl Lochungen	Artikel-Nr.	
30	1	68952-4	
40	1	68954-4	
40	2	68953-4	
60	2	68955-4	
80	2	68956-4	
100	2	68958-4	
zur Befestigung von Kassetten und Paneelen andere Breiten und Sonderlochungen auf Anfrage			

ATK 100 KL Klammern/Zubehörteile

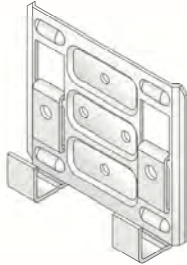

Anfangsklammer		
Material: A4 ¹⁾		
Plattendicke[mm]	Artikel-Nr.	
8	100C08	
9,5	100C09	
10,5	100C10	
11,5	100C11	
13	100C13	
Grundplatte schwarz, Klammer farbbeschichtet nach RAL oder Musterplatte. Kleinmengen zzgl. MMZ.		

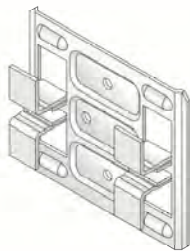

Fugenklammer		
Material: A4 ¹⁾		
Plattendicke[mm]	Artikel-Nr.	
8	100A08	
9,5	100A09	
10,5	100A10	
11,5	100A11	
13	100A13	
Grundplatte schwarz, Klammer farbbeschichtet nach RAL oder Musterplatte. Kleinmengen zzgl. MMZ.		

ATK 100 KL Klammern/Zubehörteile

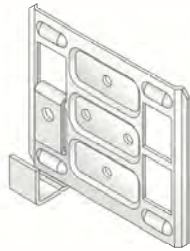

Anfangsklammer Leibung		
Material: A4 ¹⁾		
Plattendicke[mm]	Artikel-Nr.	
8	10LC08	
9,5	10LC09	
10,5	10LC10	
11,5	10LC11	
13	10LC13	
Grundplatte schwarz, Klammer farbbeschichtet nach RAL oder Musterplatte. Kleinmengen zzgl. MMZ.		

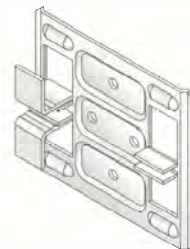

Fugenklammer Leibung		
Material: A4 ¹⁾		
Plattendicke[mm]	Artikel-Nr.	
8	10LA08	
9,5	10LA09	
10,5	10LA10	
11,5	10LA11	
13	10LA13	
Grundplatte schwarz, Klammer farbbeschichtet nach RAL oder Musterplatte. Kleinmengen zzgl. MMZ.		

ATK 100 KL Klammern/Zubehörteile



Drucklippen	
Material: EPDM schwarz	
Artikel-Nr.	
001158	



BWM-Spezialniet 3,2x8 Niro-Niro mit langem Dorn		
Material: Edelstahl ¹⁾		
Farbe	Artikel-Nr.	
blank	032800	
schwarz	03280S	
z.B. für Klammerbefestigung		



BWM-Spezialniet 3,2x10 Niro-Niro mit langem Dorn		
Material: Edelstahl ¹⁾		
Farbe	Artikel-Nr.	
blank	032100	
schwarz	03210S	
z.B. für Klammerbefestigung		

ATK 102 Minor/ATK 102 Tragprofile _____



Hauptprofil Minor		
Material: EN AW 6063 T66		
L [mm]	Artikel-Nr.	
6000	666788	



Eckprofil		
Material: EN AW 6063 T66		
L [mm]	Artikel-Nr.	
6000	668394	



Leibungsprofil		
Material: EN AW 6063 T66		
L [mm]	Artikel-Nr.	
6000	666787	

Weitere Systemprofile ATK 102 auf Anfrage

ATK 102 Minor/ATK 102 Klammern/Zubehörteile



EPDM-Profil Rolle à 150 m	
Material: EPDM schwarz	
Artikel-Nr.	
001156	

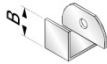

Fugenklammern		
Material: A4 ¹⁾		
Plattendicke [mm]	Artikel-Nr.	
5-8 (B=10)	102A08	
8-11 (B=12)	102A11	
10-13 (B=12)	102A13	
farbbeschichtet nach RAL oder Plattenmuster		



Distanzhalter für 8 (4) mm Fuge		
Material: A4 ¹⁾		
Plattendicke [mm]	Artikel-Nr.	
5-13	102B11	
farbbeschichtet schwarz		



Anfangsklammern		
Material: A4 ¹⁾		
Plattendicke [mm]	Artikel-Nr.	
5-8 (B=10)	102C08	
8-11 (B=12)	102C11	
11-13 (B=12)	102C13	
farbbeschichtet nach RAL oder Plattenmuster		

ATK 102 Minor/ATK 102 Klammern/Zubehörteile



Klammern zur Befestigung kleinformatiger Ziegel-/Keramikfassaden (mit 5-8mm Befestigungssteg)		
Material: A4 ¹⁾ - 1mm		
Anfangsklammern		
Schenkel B=	Artikel-Nr.	
10mm	B02C08	
6,5mm	102Z08	
5,5mm	102ZG8	
Fugenklammern **		
10mm	102A08	
6,5mm	102AK8	
5,5mm	102AG8	
** Distanzhalter auf Anfrage		

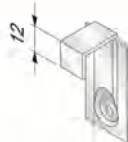

Klammern zur Befestigung großformatiger Ziegel-/Keramikfassaden (mit 8-11 + 10-13mm Befestigungssteg)		
Material: A4 ¹⁾ - 1mm		
Anfangsklammern 8-11mm		
Schenkel	Artikel-Nr.	
12mm	MO2C11	
8mm	102Z11	
Anfangsklammern 10-13mm		
12mm	B02C13	
8mm	102Z13	

ATK 102 Minor/ATK 102 Klammern/Zubehörteile



Klammern zur Befestigung großformatiger Stein- und Ziegel-/Keramikfassaden (mit 14-15mm Befestigungssteg)		
Material: A4 ¹⁾ - 1,5mm		
Anfangsklammern 8-11mm		
Schenkel	Artikel-Nr.	
12mm	102Y15	
8,5mm	102K15	
andere Materialstärken auf Anfrage		



Niet 4x8	
Material: Alu-Niro ¹⁾	
Artikel-Nr.	
320449	
z.B. für Distanzhalter und Anfangsklammern	



Niet 4x10	
Material: Alu-Niro ¹⁾	
Artikel-Nr.	
320457	
z.B. für Eckausbildung mit Leibungsprofil	

Klammern für weitere Anwendungen auf Anfrage!

ATK 100

BWM – ZeLa Click Fassadenhalter

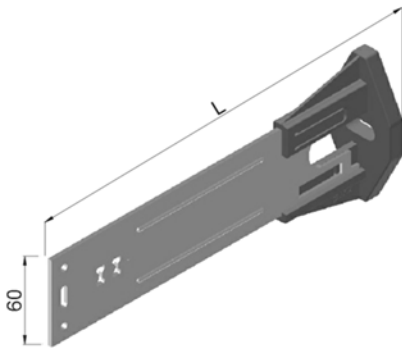

L = Schwert mit Konsole

ZeLa Click Festpunkt-/Gleitpunkt-Set		
Material: PA 66 GV 50 und EN AW 5754 H24		
Bestehend aus: ZeLa Click Konsole und ZeLa Click Schwert Aluminium		
L [mm]	Artikel-Nr.	
120	ZCSF120	
140	ZCSF140	
160	ZCSF160	
180	ZCSF180	
200	ZCSF200	
220	ZCSF220	
240	ZCSF240	
260	ZCSF260	
280	ZCSF280	
300	ZCSF300	
320	ZCSF320	
340	ZCSF340	



ATK 100

BWM – ZeLa Click Fassadenhalter

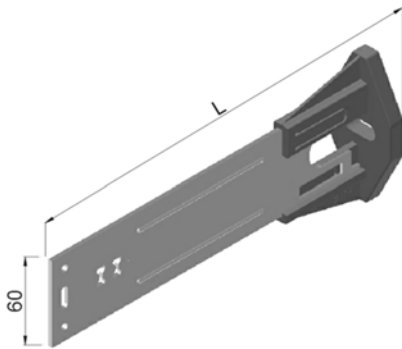

L = Schwert mit Konsole

ZeLa Click Festpunkt-/Gleitpunkt-Set Edelstahl		
Material: Konsole PA 66 GV 50 und Schwert 1.4401/1.4404		
Bestehend aus: ZeLa Click Konsole und ZeLa Click Schwert Edelstahl		
L [mm]	Artikel-Nr.	
120	ZCSF120-E	
140	ZCSF140-E	
160	ZCSF160-E	
180	ZCSF180-E	
200	ZCSF200-E	
220	ZCSF220-E	
240	ZCSF240-E	
260	ZCSF260-E	
280	ZCSF280-E	
300	ZCSF300-E	
320	ZCSF320-E	
340	ZCSF340-E	
Haltefederstanzung optional		



ATK 100

BWM – ZeLa Click Fassadenhalter



Haltefeder aus Edelstahl für ZeLa Click - Schwert	
Artikel-Nr.	
20010	



Demontageschlüssel	
Artikel-Nr.	
ZCW002	

ATK 100

BWM – Fassadenhalter ZeLa

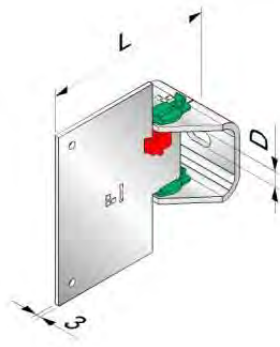

L = Schwert mit Konsole

ZeLa Festpunkt-Set groß Aluminium			
Material: EN AW 5754			
Bestehend aus: ZeLa Konsole, ZeLa Festpunkt Schwert, ZeLa Kupplung (2x) - untere Kupplung vormontiert -, ZeLa Festpunkt Clip			
Ausladung	Bodenlochung/Artikel-Nr.		
L [mm]	D=11mm	D=15mm	
100	ZeF101	ZeF105	
120	ZeF121	ZeF125	
140	ZeF141	ZeF145	
160	ZeF161	ZeF165	
180	ZeF181	ZeF185	
200	ZeF201	ZeF205	
220	ZeF221	ZeF225	
240	ZeF241	ZeF245	
260	ZeF261	ZeF265	
280	ZeF281	ZeF285	
300	ZeF301	ZeF305	
320	ZeF321	ZeF325	

Weitere Bodenlochungen und Längen auf Anfrage

Preisliste ATK 100 BWM – Fassadenhalter ZeLa

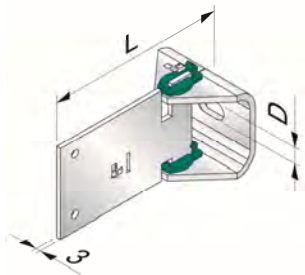

L = Schwert mit Konsole



ZeLa Gleitpunkt-Set Aluminium			
Material: EN AW 5754			
Bestehend aus: ZeLa Konsole, ZeLa Gleitpunkt Schwert, ZeLa Kupplung (2x) - untere Kupplung vormontiert -			
Ausladung	Bodenlochung/Artikel-Nr.		
L [mm]	D=11mm	D=15mm	
100	ZeG101	ZeG105	
120	ZeG121	ZeG125	
140	ZeG141	ZeG145	
160	ZeG161	ZeG165	
180	ZeG181	ZeG185	
200	ZeG201	ZeG205	
220	ZeG221	ZeG225	
240	ZeG241	ZeG245	
260	ZeG261	ZeG265	
280	ZeG281	ZeG285	
300	ZeG301	ZeG305	
320	ZeG321	ZeG325	

Thermostop für ZeLa Konsole H=50mm	
Material: Hart-PVC	
Artikel-Nr.	
055050	

Preisliste ATK 100 BWM – Fassadenhalter ZeLa

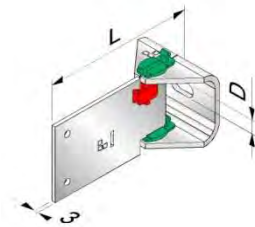

L = Schwert mit Konsole

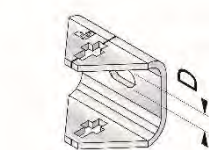
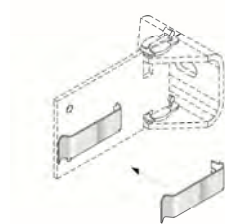

ZeLa Festpunkt-Set klein Aluminium			
Material: EN AW 5754			
Bestehend aus: ZeLa Konsole, ZeLa Gleitpunkt Schwert, ZeLa Kupplung (2x) - untere Kupplung vormontiert -, ZeLa Festpunkt Clip			
Ausladung	Bodenlochung/Artikel-Nr.		
L [mm]	D=11mm	D=15mm	
100	ZeK101	ZeK105	
120	ZeK121	ZeK125	
140	ZeK141	ZeK145	
160	ZeK161	ZeK165	
180	ZeK181	ZeK185	
200	ZeK201	ZeK205	
220	ZeK221	ZeK225	
240	ZeK241	ZeK245	
260	ZeK261	ZeK265	
280	ZeK281	ZeK285	
300	ZeK301	ZeK305	
320	ZeK321	ZeK325	

Haltefeder aus Edelstahl für ZeLa-Schwert	
Artikel-Nr.	
20010	

Einzelteile

ZeLa - Konsole		
Material: EN AW 5754		
-incl. 1x untere Kupplung vormontiert -		
D [mm]	Artikel-Nr.	
11	ZK1100	
15	ZK1500	

Preisliste ATK 100 BWM – Fassadenhalter ZeLa

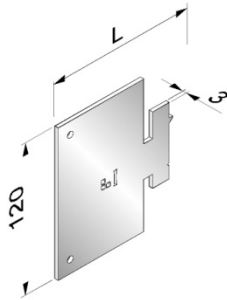

ZeLa Festpunkt-Schwert groß Aluminium		
Material: EN AW 5754		
L [mm]	Artikel-Nr.	
100	ZFS100	
120	ZFS120	
140	ZFS140	
160	ZFS160	
180	ZFS180	
200	ZFS200	
220	ZFS220	
240	ZFS240	
260	ZFS260	
280	ZFS280	
300	ZFS300	
320	ZFS320	

ZeLa Festpunkt-Clip	
Material: PA B 3 S Farbe: rot	
VPE 100 Stück	
Artikel-Nr.	
ZFC001	

Montagewerkzeug Zela-Kupplung	
Artikel-Nr.	
ZT0000	

Preisliste ATK 100
BWM – Fassadenhalter ZeLa

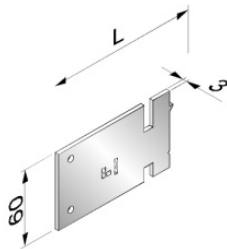

ZeLa Gleitpunkt-Schwert Aluminium		
Material: EN AW 5754		
L [mm]	Artikel-Nr.	
100	ZGS100	
120	ZGS120	
140	ZGS140	
160	ZGS160	
180	ZGS180	
200	ZGS200	
220	ZGS220	
240	ZGS240	
260	ZGS260	
280	ZGS280	
300	ZGS300	
320	ZGS320	



ZeLa Kupplung		
für 3mm Schwert		
Material: PA B 3 S Farbe: grün		
VPE 100 Stück		
Abmessung	Artikel-Nr.	
3 mm	ZTK002	

Preisliste ATK 100 BWM – Fassadenhalter ZeLa Edelstahl

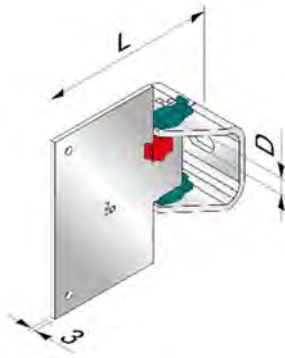

L = Schwert mit Konsole

ZeLa Festpunkt-Set groß Edelstahl			
Material: Konsole: EN AW 5754; Schwert: 1.4401/1.4404 ¹⁾			
Bestehend aus: ZeLa Konsole, ZeLa Festpunkt Schwert, ZeLa Kupplung (2x) - untere Kupplung vormontiert -, ZeLa Festpunkt Clip			
Ausladung	Bodenlochung/Artikel-Nr.		
L [mm]	D=11mm	D=15mm	
120	ZeF121-E	ZeF125-E	
140	ZeF141-E	ZeF145-E	
160	ZeF161-E	ZeF165-E	
180	ZeF181-E	ZeF185-E	
200	ZeF201-E	ZeF205-E	
220	ZeF221-E	ZeF225-E	
240	ZeF241-E	ZeF245-E	
260	ZeF261-E	ZeF265-E	
280	ZeF281-E	ZeF285-E	
300	ZeF301-E	ZeF305-E	
320	ZeF321-E	ZeF325-E	

Weitere Bodenlochungen und Längen auf Anfrage

Preisliste ATK 100 BWM – Fassadenhalter ZeLa Edelstahl

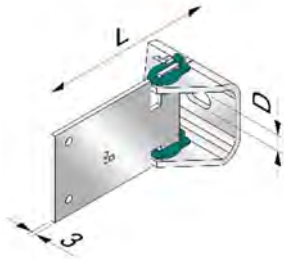

L = Schwert mit Konsole

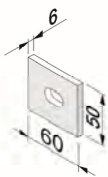

ZeLa Gleitpunkt-Set Edelstahl			
Material: Konsole: EN AW 5754; Schwert: 1.4401/1.4404 ¹⁾			
Bestehend aus: ZeLa Konsole, ZeLa Gleitpunkt Schwert , ZeLa Kupplung (2x) - untere Kupplung vormontiert -			
Ausladung	Bodenlochungen/Artikel-Nr.		
L [mm]	D=11mm	D=15mm	
120	ZeG121-E	ZeG125-E	
140	ZeG141-E	ZeG145-E	
160	ZeG161-E	ZeG165-E	
180	ZeG181-E	ZeG185-E	
200	ZeG201-E	ZeG205-E	
220	ZeG221-E	ZeG225-E	
240	ZeG241-E	ZeG245-E	
260	ZeG261-E	ZeG265-E	
280	ZeG281-E	ZeG285-E	
300	ZeG301-E	ZeG305-E	
320	ZeG321-E	ZeG325-E	

Thermostop für ZeLa Konsole H=50mm	
Material: Hart-PVC	
Artikel-Nr.	
055050	

Preisliste ATK 100

BWM – Fassadenhalter ZeLa Edelstahl

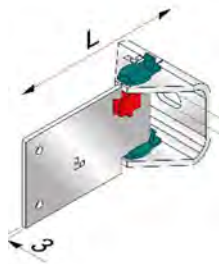

L = Schwert mit Konsole

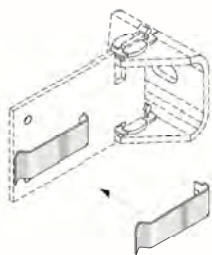

ZeLa Festpunkt-Set klein Edelstahl			
Material: Konsole: EN AW 5754; Schwert: 1.4401/1.4404 ¹⁾			
Bestehend aus: ZeLa Konsole, ZeLa Gleitpunkt Schwert, ZeLa Kupplung (2x) - untere Kupplung vormontiert -, ZeLa Festpunkt Clip			
Ausladung	Bodenlochungen/Artikel-Nr.		
L [mm]	D=11mm	D=15mm	
120	ZeK121-E	ZeK125-E	
140	ZeK141-E	ZeK145-E	
160	ZeK161-E	ZeK165-E	
180	ZeK181-E	ZeK185-E	
200	ZeK201-E	ZeK205-E	
220	ZeK221-E	ZeK225-E	
240	ZeK241-E	ZeK245-E	
260	ZeK261-E	ZeK265-E	
280	ZeK281-E	ZeK285-E	
300	ZeK301-E	ZeK305-E	
320	ZeK321-E	ZeK325-E	

Haltefeder aus Edelstahl für ZeLa-Schwert	
Artikel-Nr.	
20010	
Haltefederstanzung optional	

ZeLa - Konsole		
Material: EN AW 5754		
-incl. 1x untere Kupplung vormontiert -		
D [mm]	Artikel-Nr.	
11	ZK1100	
15	ZK1500	

Preisliste ATK 100
BWM – Fassadenhalter ZeLa Edelstahl
Einzelteile

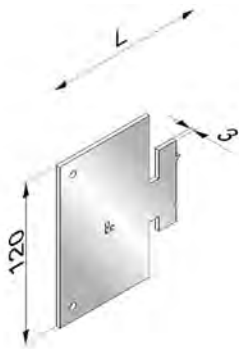

ZeLa Festpunkt-Schwert Edelstahl		
Material: 1.4401/1.4404 ¹⁾		
L [mm]	Artikel-Nr.	
120	ZFS120-E	
140	ZFS140-E	
160	ZFS160-E	
180	ZFS180-E	
200	ZFS200-E	
220	ZFS220-E	
240	ZFS240-E	
260	ZFS260-E	
280	ZFS280-E	
300	ZFS300-E	
320	ZFS320-E	



ZeLa Festpunkt-Clip	
Material: PA B 3 S Farbe: rot	
VPE 100 Stück	
Artikel-Nr.	
ZFC001	



Montagewerkzeug Zela-Kupplung	
Artikel-Nr.	
ZT0000	

Preisliste ATK 100 BWM – Fassadenhalter ZeLa Edelstahl

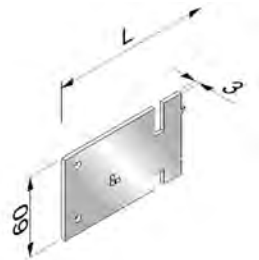

ZeLa Gleitpunkt-Schwert Edelstahl		
Material: 1.4401/1.4404 ¹⁾		
L [mm]	Artikel-Nr.	
120	ZGS120-E	
140	ZGS140-E	
160	ZGS160-E	
180	ZGS180-E	
200	ZGS200-E	
220	ZGS220-E	
240	ZGS240-E	
260	ZGS260-E	
280	ZGS280-E	
300	ZGS300-E	
320	ZGS320-E	



ZeLa Kupplung		
für 3mm Schwert		
Material: PA B 3 S Farbe: grün		
VPE 100 Stück		
Abmessung	Artikel-Nr.	
3 mm	ZTK002	

Preisliste ATK 100 Wandwinkel

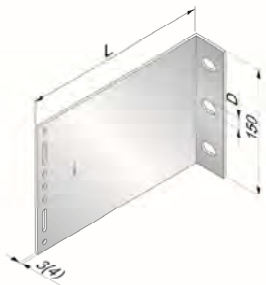

*) ohne Aufnahme für Haltefeder

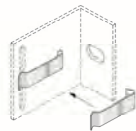

Wandwinkel H=150mm t=3-4,3 mm				
Verwendbar als Fest-, Gleit- oder Gleit-/Festpunkt				
Material: EN AW 6063 T66				
Ausladung	Artikel-Nr.		weitere Langlöcher	
	Bodenlochung		D= 6,5/ 9,0/13,0	
L [mm]	D=11mm	D=15mm	t=[mm]	
40 *	1040150	5040150	3	
60	061150	065150	3	
80	081150	085150	3	
100	101150	105150	3	
120	121150	125150	3	
140	141150	145150	3	
160	161150	165150	3	
180	181150	185150	3	
200	201150	205150	3	
220	221150	225150	3-3,5	
240	241150	245150	3-4	
260	261150	265150	3-4	
280	281150	285150	3-4	
300	301150	305150	3-4,1	
320	321150	325150	3-4,3	

Haltefeder aus Edelstahl	
Artikel-Nr.	
20010	

Verlängerungen für Wandwinkel		
Verwendbar als Fest-, Gleit- oder Gleit-/Festpunkt		
H [mm]	Artikel-Nr.	
150	WVL150	

Preisliste ATK 100 Wandwinkel

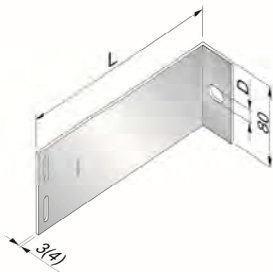

*) ohne Aufnahme für Haltefeder

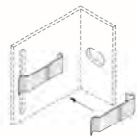

Wandwinkel H=80mm t=3-4,3 mm				
Verwendbar als Gleitpunkt				
Material: EN AW 6063 T66				
Ausladung	Artikel-Nr.		weitere Langlöcher	
	Bodenlochung		D= 6,5/ 9,0/13,0	
L [mm]	D=11mm	D=15mm	t=[mm]	
40 *	1040080	5040080	3	
60	061080	065080	3	
80	081080	085080	3	
100	101080	105080	3	
120	121080	125080	3	
140	141080	145080	3	
160	161080	165080	3	
180	181080	185080	3	
200	201080	205080	3	
220	221080	225080	3-3,5	
240	241080	245080	3-4	
260	261080	265080	3-4	
280	281080	285080	3-4	
300	301080	305080	3-4,1	
320	321080	325080	3-4,3	

Haltefeder aus Edelstahl	
Artikel-Nr.	
20010	

Verlängerungen für Wandwinkel		
Verwendbar als Gleitpunkt		
H [mm]	Artikel-Nr.	
80	WVLG80	

Preisliste ATK 100 Wandwinkel



*) ohne Aufnahme für Haltefeder



Wandwinkel H=80mm t=3-4,3 mm				
Verwendbar als Festpunkt				
Material: EN AW 6063 T66				
Ausladung	Artikel-Nr.		weitere Langlöcher	
	Bodenlochung		D= 6,5/ 9,0/13,0	
L [mm]	D=11mm	D=15mm	t=[mm]	
40 *	1040081	5040081	3	
60	061081	065081	3	
80	081081	085081	3	
100	101081	105081	3	
120	121081	125081	3	
140	141081	145081	3	
160	161081	165081	3	
180	181081	185081	3	
200	201081	205081	3	
220	221081	225081	3-3,5	
240	241081	245081	3-4	
260	261081	265081	3-4	
280	281081	285081	3-4	
300	301081	305081	3-4,1	
320	321081	325081	3-4,3	

Haltefeder aus Edelstahl	
Artikel-Nr.	
20010	

Verlängerungen für Wandwinkel		
Verwendbar als Festpunkt		
H [mm]	Artikel-Nr.	
80	WVLF80	

Preisliste ATK 100 Wandwinkel

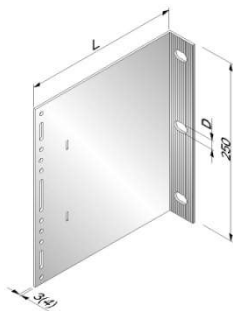

*) ohne Aufnahme für Haltefeder



Wandwinkel H=250mm t=3-4,3 mm				
Verwendbar als Fest-, Gleit- oder Gleit-/Festpunkt				
Trennschicht am Halterboden auf Anfrage				
Material: EN AW 6063 T66				
Ausladung	Artikel-Nr.		weitere Langlöcher	
	Bodenlochung		D= 6,5/ 9,0/13,0	
L [mm]	D=11mm	D=15mm	t=[mm]	
40 *	1040250	5040250	3	
60	061250	065250	3	
80	081250	085250	3	
100	101250	105250	3	
120	121250	125250	3	
140	141250	145250	3	
160	161250	165250	3	
180	181250	185250	3	
200	201250	205250	3	
220	221250	225250	3-3,5	
240	241250	245250	3-4	
260	261250	265250	3-4	
280	281250	285250	3-4	
300	301250	305250	3-4,1	
320	321250	325250	3-4,3	

Haltefeder aus Edelstahl	
Artikel-Nr.	
20010	

Verlängerungen für Wandwinkel		
Verwendbar als Fest-, Gleit- oder Gleit-/Festpunkt		
H [mm]	Artikel-Nr.	
250	WVL250	

Preisliste ATK 100 Wandwinkel



*) ohne Aufnahme für Haltefeder



Wandwinkel H=300mm t=3-4,3 mm				
Verwendbar als Fest-, Gleit- oder Gleit-/Festpunkt				
Material: EN AW 6063 T66				
Ausladung	Artikel-Nr.		weitere Langlöcher	
	Bodenlochung		D= 6,5/ 9,0/13,0	
L [mm]	D=11mm	D=15mm	t=[mm]	
40 *	1040300	5040300	3	
60	061300	065300	3	
80	081300	085300	3	
100	101300	105300	3	
120	121300	125300	3	
140	141300	145300	3	
160	161300	165300	3	
180	181300	185300	3	
200	201300	205300	3	
220	221300	225300	3-3,5	
240	241300	245300	3-4	
260	261300	265300	3-4	
280	281300	285300	3-4	
300	301300	305300	3-4,1	
320	321300	325300	3-4,3	

Haltefeder aus Edelstahl	
Artikel-Nr.	
20010	

Verlängerungen für Wandwinkel		
Verwendbar als Fest-, Gleit- oder Gleit-/Festpunkt		
H [mm]	Artikel-Nr.	
300	WVL300	

Preisliste

Wandwinkel gekantet t=5mm - 8mm

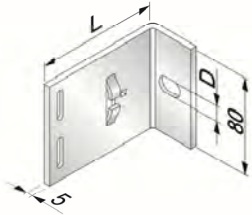

Wandwinkel gekantet H=80mm t=5 – 8mm		
Verwendbar als Gleitpunkt		
Material: EN AW 5754 H24/H34		
	Artikel-Nr.	
Ausladung	Bodenlochung	
L [mm]	D=11mm	D=15mm
ab 340	auf Anfrage	

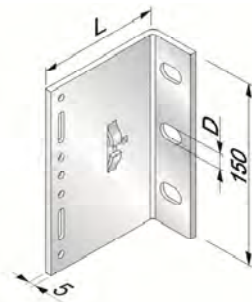

Wandwinkel gekantet H=150mm t=5 – 8mm		
Verwendbar als Fest-, Gleit- oder Gleit-/Festpunkt		
Material: EN AW 5754 H24/H34		
	Artikel-Nr.	
Ausladung	Bodenlochung	
L [mm]	D=11mm	D=15mm
ab 340	auf Anfrage	

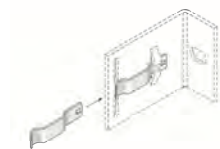

Haltefeder aus Edelstahl für gekantete Wandwinkel	
Artikel-Nr.	
20010A	
Haltefederstanzung kein Standard	

Preisliste

Thermostop (selbstklebend) für Wandwinkel



Thermostop für Wandwinkel H=80mm	
Material: Hart-PVC	
Artikel-Nr.	
040080	



Thermostop für Wandwinkel H=150mm	
Material: Hart-PVC	
Artikel-Nr.	
040150	



Thermostop für Wandwinkel H=250mm	
Material: Hart-PVC	
Artikel-Nr.	
040250	



Thermostop für Wandwinkel H=300mm	
Material: Hart-PVC	
Artikel-Nr.	
040300	

Preisliste Zubehörteile



BWM Spezialniet SNA 5x12 K14	
Material: Alu-Niro ¹⁾ (grün eloxiert)	
Artikel-Nr.	
051214	
z.B. für Wandwinkel / ZeLa Click / ZeLa	



Bohrschrauben		
Material: A2 ¹⁾ bzw. A4 ²⁾		
Bezeichnung	Artikel-Nr.	Euro/Hdt.
JT4-3H/5-5,5x19	111463 ¹⁾	
SDA5/3.5-8-H13-S4-5,5x22	630271 ²⁾	
z.B. für Wandwinkel / ZeLa Click / ZeLa/ FLH R		



U-Scheibe geriffelt		
Material: EN AW 6063 T66		
D [mm]	Artikel-Nr.	
10,5	200105	
12,5	200125	
14,5	200145	
z.B. für Wandwinkel		

Preisliste ATK 100 FLH R Edelstahlwandhalter



FLH R Wandhalter H=70 Edelstahl		
Material: Edelstahl 1.4162		
VPE 40 St.		
Abmessungen L [mm]	Artikel-Nr.	
FLH 120x70x1,5/10,5/F-SP R	562800	
FLH 140x70x1,5/10,5/F-SP R	562801	
FLH 160x70x1,5/10,5/F-SP R	562802	
FLH 180x70x1,5/10,5/F-SP R	562803	
FLH 200x70x1,5/10,5/F-SP R	562804	
FLH 220x70x1,5/10,5/F-SP R	562805	
FLH 240x70x1,5/10,5/F-SP R	562806	
FLH 260x70x1,5/10,5/F-SP R	562807	
FLH 280x70x1,5/10,5/F-SP R	562808	
FLH 300x70x1,5/10,5/F-SP R	562809	
FLH 320x70x1,5/10,5/F-SP R	562810	
FLH 340x70x1,5/10,5/F-SP R	562811	



Zubehör		
Material: Edelstahl 1.4162		
Artikelbezeichnung	Artikel-Nr.	
Haltefeder	20010	
U-Scheibe 11,5 FLH-R	562813	
U-Scheibe 11,5/2x6,6 FLH-R	562812	

Preisliste ATK 100 FLH R Edelstahlwandhalter



FLH R Wandhalter H=147 Edelstahl		
Material: Edelstahl 1.4162		
VPE: 20 Stück		
Abmessungen L [mm]	Artikel-Nr.	
FLH 120x147x1,5/10,5/F-SP R	562788	
FLH 140x147x1,5/10,5/F-SP R	562789	
FLH 160x147x1,5/10,5/F-SP R	562790	
FLH 180x147x1,5/10,5/F-SP R	562791	
FLH 200x147x1,5/10,5/F-SP R	562792	
FLH 220x147x1,5/10,5/F-SP R	562793	
FLH 240x147x1,5/10,5/F-SP R	562794	
FLH 260x147x1,5/10,5/F-SP R	562795	
FLH 280x147x1,5/10,5/F-SP R	562796	
FLH 300x147x1,5/10,5/F-SP R	562797	
FLH 320x147x1,5/10,5/F-SP R	562798	
FLH 340x147x1,5/10,5/F-SP R	562799	



Zubehör		
Material: Edelstahl 1.4162		
Artikelbezeichnung	Artikel-Nr.	
Haltefeder	20010	
U-Scheibe 10,5 FLH-R	562813	
U-Scheibe 10,5/2x6,6 FLH-R	562812	

Preisliste ATK 101 Tragprofile



Hutprofil		
Material: EN AW 6063 T66		
L [mm]	Artikel-Nr.	
6000	663803	



Kastenprofil		
Material: EN AW 6063 T66		
L [mm]	Artikel-Nr.	
6000	666000	



PI-Profil -110		
Material: EN AW 6063 T66		
[mm]	Artikel-Nr.	
6000*	668807	



PI-Profil -60		
Material: EN AW 6063 T66		
L [mm]	Artikel-Nr.	
6000	668806	



U-Tragprofil		
Material: EN AW 6063 T66		
L [mm]	Artikel-Nr.	
6000	668305	

Preisliste ATK 101

U – Halter Typ N LW 44 t=3mm

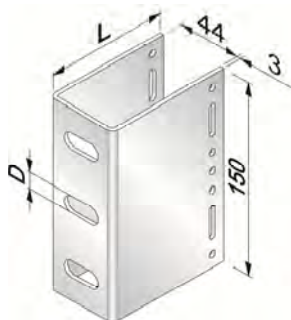

U-Halter Typ N LW 44 H=150mm t=3mm			
Verwendbar als Fest-, Gleit- oder Gleit-/Festpunkt			
Material: EN AW 5754 H24/H34			
	Artikel-Nr.		
Ausladung	Bodenlochung		
L [mm]	D=11mm	D=6,5mm	
60	061152	auf Anfrage	
80	081152	auf Anfrage	
100	101152	auf Anfrage	
120	121152	auf Anfrage	
140	141152	auf Anfrage	
160	161152	auf Anfrage	
180	181152	auf Anfrage	
Weitere Abmessungen auf Anfrage			

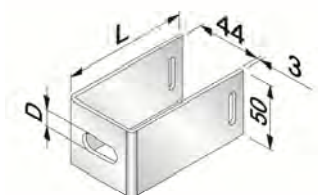

U-Halter Typ N LW 44 H=50mm t=3mm			
Verwendbar als Gleitpunkt			
Material: EN AW 5754 H24/H34			
	Artikel-Nr.		
Ausladung	Bodenlochung		
L [mm]	D=11mm	D=6,5mm	
60	061052	auf Anfrage	
80	081052	auf Anfrage	
100	101052	auf Anfrage	
120	121052	auf Anfrage	
140	141052	auf Anfrage	
160	161052	auf Anfrage	
180	181052	auf Anfrage	
Weitere Abmessungen auf Anfrage			

Preisliste ATK 101

U – Halter Typ N LW 44 t=3mm

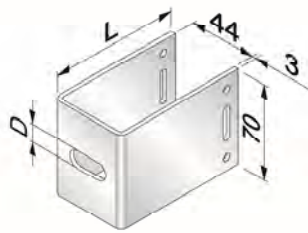

U-Halter Typ N LW 44 H=70mm t=3mm			
Verwendbar als Fest- oder Gleitpunkt			
Material: EN AW 5754 H24/H34			
	Artikel-Nr.		
Ausladung	Bodenlochung		
L [mm]	D=11mm	D=6,5mm	
60	061072	auf Anfrage	
80	081072	auf Anfrage	
100	101072	auf Anfrage	
120	121072	auf Anfrage	
140	141072	auf Anfrage	
160	161072	auf Anfrage	
180	181072	auf Anfrage	
Weitere Abmessungen auf Anfrage			

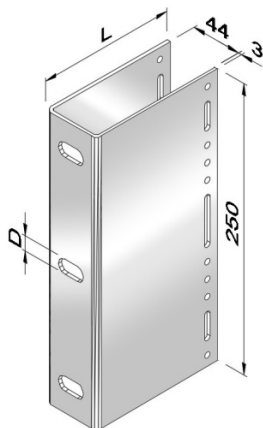

U-Halter Typ N LW 44 H=250mm t=3mm			
Verwendbar als Fest-, Gleit- oder Gleit-/Festpunkt			
Material: EN AW 5754 H24/H34			
	Artikel-Nr.		
Ausladung	Bodenlochung		
L [mm]	D=11mm	D=6,5mm	
60	061252	auf Anfrage	
80	081252	auf Anfrage	
100	101252	auf Anfrage	
120	121252	auf Anfrage	
140	141252	auf Anfrage	
160	161252	auf Anfrage	
180	181252	auf Anfrage	
Weitere Abmessungen auf Anfrage			

Preisliste ATK 101

U – Halter Typ N LW 44 t=4mm

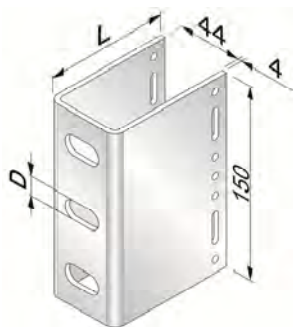

U-Halter Typ N LW 44 H=150mm t=4mm			
Verwendbar als Fest-, Gleit- oder Gleitfestpunkt			
Material: EN AW 5754 H24/H34			
		Artikel-Nr.	
Ausladung	Bodenlochung		
L [mm]	D=11mm	D=6,5mm	
60	061157	auf Anfrage	
80	081157	auf Anfrage	
100	101157	auf Anfrage	
120	121157	auf Anfrage	
140	141157	auf Anfrage	
160	161157	auf Anfrage	
180	181157	auf Anfrage	
Weitere Abmessungen auf Anfrage			

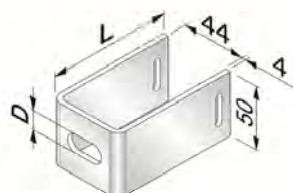

U-Halter Typ N LW 44 H=50mm t=4mm			
Verwendbar als Gleitpunkt			
Material: EN AW 5754 H24/H34			
		Artikel-Nr.	
Ausladung	Bodenlochung		
L [mm]	D=11mm	D=6,5mm	
60	061057	auf Anfrage	
80	081057	auf Anfrage	
100	101057	auf Anfrage	
120	121057	auf Anfrage	
140	141057	auf Anfrage	
160	161057	auf Anfrage	
180	181057	auf Anfrage	
Weitere Abmessungen auf Anfrage			

Preisliste ATK 101

U – Halter Typ N LW 44 t=4mm

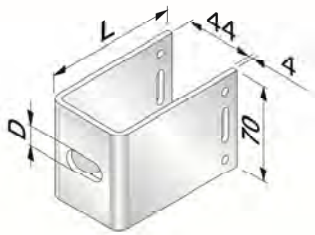

U-Halter Typ N LW 44 H=70mm t=4mm			
Verwendbar als Fest- oder Gleitpunkt			
Material: EN AW 5754 H24/H34			
	Artikel-Nr.		
Ausladung	Bodenlochung		
L [mm]	D=11mm	D=6,5mm	
60	061077	auf Anfrage	
80	081077	auf Anfrage	
100	101077	auf Anfrage	
120	121077	auf Anfrage	
140	141077	auf Anfrage	
160	161077	auf Anfrage	
180	181077	auf Anfrage	
Weitere Abmessungen auf Anfrage			

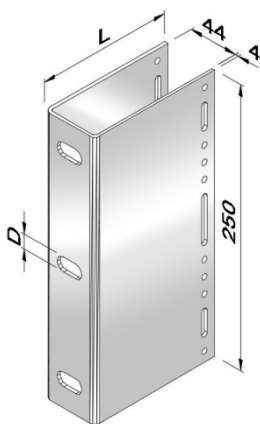

U-Halter Typ N LW 44 H=250mm t=4mm			
Verwendbar als Fest-, Gleit- oder Gleit-/Festpunkt			
Material: EN AW 5754 H24/H34			
	Artikel-Nr.		
Ausladung	Bodenlochung		
L [mm]	D=11mm	D=6,5mm	
60	061257	auf Anfrage	
80	081257	auf Anfrage	
100	101257	auf Anfrage	
120	121257	auf Anfrage	
140	141257	auf Anfrage	
160	161257	auf Anfrage	
180	181257	auf Anfrage	
Weitere Abmessungen auf Anfrage			

Preisliste ATK 101

U – Halter Typ N LW 44 t=3mm

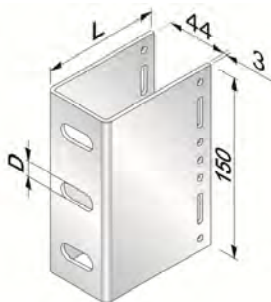

U-Halter Typ N LW 44 H=150mm t=3mm			
Verwendbar als Fest-, Gleit- oder Gleitfestpunkt			
Material: EN AW 5754 H24/H34			
Ausladung	Artikel-Nr.		
	Bodenlochung		
L [mm]	D=11mm	D=15mm	
60-180	t=3mm siehe Seite 44-45		
200	201152	205152	
220	221152	225152	
240	241152	245152	
260	261152	265152	
280	281152	285152	
300	301152	305152	
320	321152	325152	

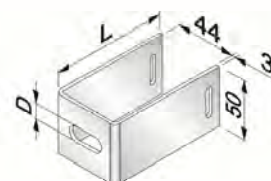

U-Halter Typ N LW 44 H=50mm t=3mm			
Verwendbar als Gleitpunkt			
Material: EN AW 5754 H24/H34			
Ausladung	Artikel-Nr.		
	Bodenlochung		
L [mm]	D=11mm	D=15mm	
60-180	t=3mm siehe Preisliste Seite 44-45		
200	201052	205052	
220	221052	225052	
240	241052	245052	
260	261052	265052	
280	281052	285052	
300	301052	305052	
320	321052	325052	

Preisliste ATK 101
U – Halter Typ N LW 44 t=3mm

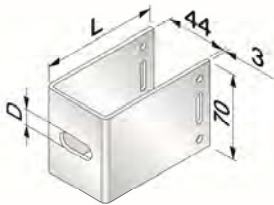

U-Halter Typ N LW 44 H=70mm t=3mm			
Verwendbar als Fest- oder Gleitpunkt			
Material: EN AW 5754 H24/H34			
Ausladung	Artikel-Nr.		
	Bodenlochung		
L [mm]	D=11mm	D=15mm	
60-180	t=3mm siehe Seite 44-45		
200	201072	205072	
220	221072	225072	
240	241072	245072	
260	261072	265072	
280	281072	285072	
300	301072	305072	
320	321072	325072	

U-Halter Typ N in Edelstahl 1.4162 auf Anfrage

Preisliste ATK 101

U – Halter Typ N LW 44 t=4mm

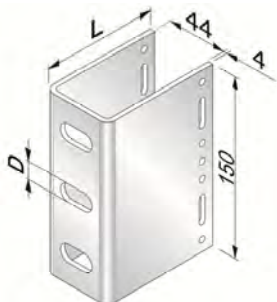

U-Halter Typ N LW 44 H=150mm t=4mm			
Verwendbar als Fest-, Gleit- oder Gleitfestpunkt			
Material: EN AW 5754 H24/H34			
Ausladung	Artikel-Nr.		
	Bodenlochung		
L [mm]	D=11mm	D=15mm	
60-180	t=4mm siehe Seite 46-47		
200	201153	205153	
220	221153	225153	
240	241153	245153	
260	261153	265153	
280	281153	285153	
300	301153	305153	
320	321153	325153	

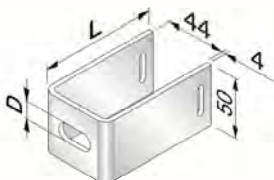

U-Halter Typ N LW 44 H=50mm t=4mm			
Verwendbar als Gleitpunkt			
Material: EN AW 5754 H24/H34			
Ausladung	Artikel-Nr.		
	Bodenlochung		
L [mm]	D=11mm	D=15mm	
60-180	t=4mm siehe Preisliste Seite 46-47		
200	201053	205053	
220	221053	225053	
240	241053	245053	
260	261053	265053	
280	281053	285053	
300	301053	305053	
320	321053	325053	

Preisliste ATK 101
U – Halter Typ N LW 44 t=4mm

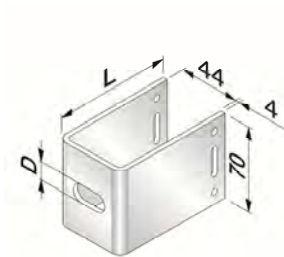

U-Halter Typ N LW 44 H=70mm t=4mm			
Verwendbar als Fest- oder Gleitpunkt			
Material: EN AW 5754 H24/H34			
Ausladung	Artikel-Nr.		
	Bodenlochung		
L [mm]	D=11mm	D=15mm	
60-180	t=4mm siehe Seite 46-47		
200	201073	205073	
220	221073	225073	
240	241073	245073	
260	261073	265073	
280	281073	285073	
300	301073	305073	
320	321073	325073	

U-Halter Typ N in Edelstahl 1.4162 auf Anfrage

Preisliste

Thermostop (selbstklebend) für

U-Halter Typ N und Zubehör

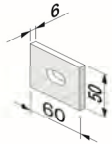

Thermostop für U-Halter H=50mm	
Material: Hart-PVC	
Artikel-Nr.	
055050	

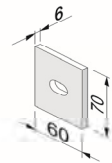

Thermostop für U-Halter H=70mm	
Material: Hart-PVC	
Artikel-Nr.	
055070	



Thermostop für U-Halter H=150mm	
Material: Hart-PVC	
Artikel-Nr.	
055150	



Thermostop für U-Halter H=250mm	
Material: Hart-PVC	
Artikel-Nr.	
055250	



BWM Spezialniet SNA 5x12 K14	
Material: Alu-Niro ¹⁾ (grün eloxiert)	
Artikel-Nr.	
051214	
z.B. für U-Halter Typ N	

Preisliste ATK 106 SZ 20 Tragprofile



Basisprofil SZ 20		
Material: EN AW 6063 T66		
passend für Alucobond		
L [mm]	Artikel-Nr.	
6000	663003	



Z-Profil SZ 20		
Material: EN AW 6063 T66		
passend für Alucobond		
L [mm]	Artikel-Nr.	
6000	663001	



S-Profil SZ 20		
Material: EN AW 6063 T66		
passend für Alucobond		
L [mm]	Artikel-Nr.	
6000	663002	



Hutprofil SZ 20		
Material: EN AW 6063 T66		
passend für Alucobond		
L [mm]	Artikel-Nr.	
6000	663004	



Kunststoffclip SZ 20		
Material:		
passend für Alucobond		
Artikel-Nr.		
SZ1989		

U – Halter Typ N LW 50 t=3mm

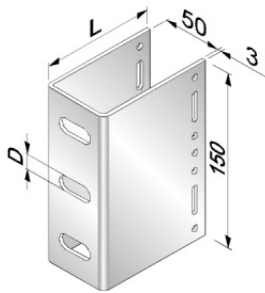

U-Halter Typ N LW 50 H=150mm t=3mm			
Verwendbar als Fest-, Gleit- oder Gleit-/Festpunkt			
Material: EN AW 5754 H24/H34			
Ausladung	Artikel-Nr.		
	Bodenlochung		
L [mm]	D=11mm	D=15mm	
60	1519060	1559060	
80	1519080	1559080	
100	1519100	1559100	
120	1519120	1559120	
140	1519140	1559140	
160	1519160	1559160	
180	1519180	1559180	
200	1519200	1559200	
220	1519220	1559220	
240	1519240	1559240	
260	1519260	1559260	
280	1519280	1559280	
300	1519300	1559300	
320	1519320	1559320	
weitere Abmessungen auf Anfrage			

U – Halter Typ N LW 50 t=3mm

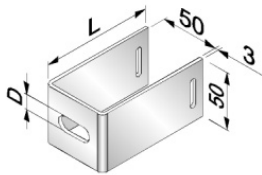

U-Halter Typ N LW 50 H=50mm t=3mm			
Verwendbar als Gleitpunkt			
Material: EN AW 5754 H24/H34			
Ausladung	Artikel-Nr.		
	Bodenlochung		
L [mm]	D=11mm	D=15mm	
60	0519060	0559060	
80	0519080	0559080	
100	0519100	0559100	
120	0519120	0559120	
140	0519140	0559140	
160	0519160	0559160	
180	0519180	0559180	
200	0519200	0559200	
220	0519220	0559220	
240	0519240	0559240	
260	0519260	0559260	
280	0519280	0559280	
300	0519300	0559300	
320	0519320	0559320	
weitere Abmessungen auf Anfrage			

U – Halter Typ N LW 50 t=3mm

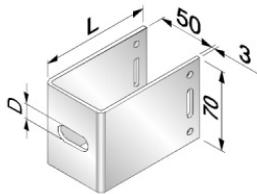

U-Halter Typ N LW 50 H=70mm t=3mm			
Verwendbar als Fest- oder Gleitpunkt			
Material: EN AW 5754 H24/H34			
Ausladung	Artikel-Nr.		
	Bodenlochung		
L [mm]	D=11mm	D=15mm	
60	0719060	0759060	
80	0719080	0759080	
100	0719100	0759100	
120	0719120	0759120	
140	0719140	0759140	
160	0719160	0759160	
180	0719180	0759180	
200	0719200	0759200	
220	0719220	0759220	
240	0719240	0759240	
260	0719260	0759260	
280	0719280	0759280	
300	0719300	0759300	
320	0719320	0759320	
weitere Abmessungen auf Anfrage			

U-Halter Typ N in Edelstahl 1.4162 auf Anfrage

U – Halter Typ N LW 50 t=4mm

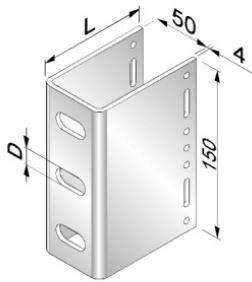

U-Halter Typ N LW 50 H=150mm t=4mm			
Verwendbar als Fest-, Gleit- oder Gleit-/Festpunkt			
Material: EN AW 5754 H24/H34			
Ausladung	Artikel-Nr.		
	Bodenlochung		
L [mm]	D=11mm	D=15mm	
60	1519064	1559064	
80	1519084	1559084	
100	1519104	1559104	
120	1519124	1559124	
140	1519144	1559144	
160	1519164	1559164	
180	1519184	1559184	
200	1519204	1559204	
220	1519224	1559224	
240	1519244	1559244	
260	1519264	1559264	
280	1519284	1559284	
300	1519304	1559304	
320	1519324	1559324	
weitere Abmessungen auf Anfrage			

U – Halter Typ N LW 50 t=4mm

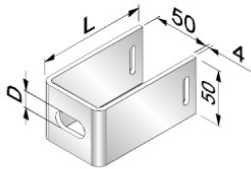

U-Halter Typ N LW 50 H=50mm t=4mm			
Verwendbar als Gleitpunkt			
Material: EN AW 5754 H24/H34			
Ausladung	Artikel-Nr.		
	Bodenlochung		
L [mm]	D=11mm	D=15mm	
60	0519064	0559064	
80	0519084	0559084	
100	0519104	0559104	
120	0519124	0559124	
140	0519144	0559144	
160	0519164	0559164	
180	0519184	0559184	
200	0519204	0559204	
220	0519224	0559224	
240	0519244	0559244	
260	0519264	0559264	
280	0519284	0559284	
300	0519304	0559304	
320	0159324	0559324	
weitere Abmessungen auf Anfrage			

U – Halter Typ N LW 50 t=4mm

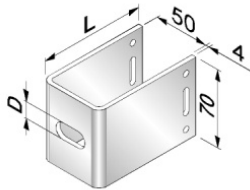

U-Halter Typ N LW 50 H=70mm t=4mm			
Verwendbar als Fest- oder Gleitpunkt			
Material: EN AW 5754 H24/H34			
Ausladung	Artikel-Nr.		
	Bodenlochung		
L [mm]	D=11mm	D=15mm	
60	0719064	0759064	
80	0719084	0759084	
100	0719104	0759104	
120	0719124	0759124	
140	0719144	0759144	
160	0719164	0759164	
180	0719184	0759184	
200	0719204	0759204	
220	0719224	0759224	
240	0719244	0759244	
260	0719264	0759264	
280	0719284	0759284	
300	0719304	0759304	
320	0719324	0759324	
weitere Abmessungen auf Anfrage			

U-Halter Typ N in Edelstahl 1.4162 auf Anfrage

ATK 107 B

Systemteile

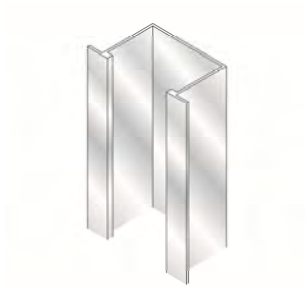

Halteprofil		
Material: EN AW 6063 T66		
L [mm]	Artikel-Nr.	
6000	668526	

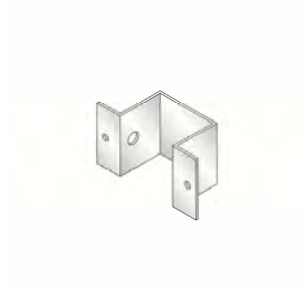

Bolzenprofil		
Material: EN AW 6063 T66		
L [mm]	Artikel-Nr.	
50	068527	



Bolzen		
Material: A4 ¹⁾		
D [mm]	Artikel-Nr.	
10h11	068528	



Clip ohne Aushebesicherung	
Material: Kunststoff	
Artikel-Nr.	
068530	

U – Halter Typ N LW 70 t=3mm

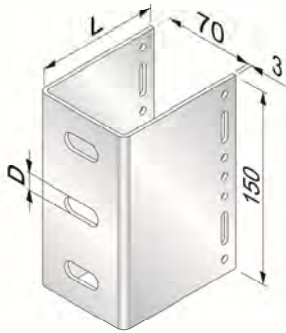

U-Halter Typ N LW 70 H=150mm t=3mm			
Verwendbar als Fest-, Gleit- oder Gleit-/Festpunkt			
Material: EN AW 5754 H24/H34			
Ausladung	Artikel-Nr.		
	Bodenlochung		
L [mm]	D=11mm	D=15mm	
60	061154	065154	
80	081154	085154	
100	101154	105154	
120	121154	125154	
140	141154	145154	
160	161154	165154	
180	181154	185154	
200	201154	205154	
220	221154	225154	
240	241154	245154	
260	261154	265154	
280	281154	285154	
300	301154	305154	
320	321154	325154	
weitere Abmessungen auf Anfrage			

U – Halter Typ N LW 70 t=3mm

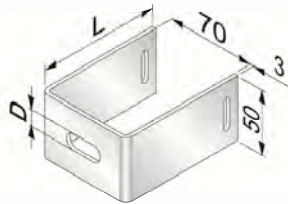

U-Halter Typ N LW 70 H=50mm t=3mm			
Verwendbar als Gleitpunkt			
Material: EN AW 5754 H24/H34			
Ausladung	Artikel-Nr.		
	Bodenlochung		
L [mm]	D=11mm	D=15mm	
60	061054	065054	
80	081054	085054	
100	101054	105054	
120	121054	125054	
140	141054	145054	
160	161054	165054	
180	181054	185054	
200	201054	205054	
220	221054	225054	
240	241054	245054	
260	261054	265054	
280	281054	285054	
300	301054	305054	
320	321054	325054	
weitere Abmessungen auf Anfrage			

U – Halter Typ N LW 70 t=3mm

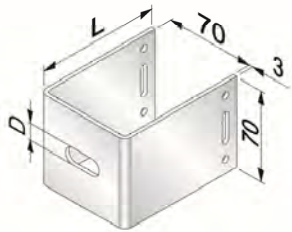

U-Halter Typ N LW 70 H=70mm t=3mm			
Verwendbar als Fest- oder Gleitpunkt			
Material: EN AW 5754 H24/H34			
Ausladung	Artikel-Nr.		
	Bodenlochung		
L [mm]	D=11mm	D=15mm	
60	061074	065074	
80	081074	085074	
100	101074	105074	
120	121074	125074	
140	141074	145074	
160	161074	165074	
180	181074	185074	
200	201074	205074	
220	221074	225074	
240	241074	245074	
260	261074	265074	
280	281074	285074	
300	301074	305074	
320	321074	325074	
weitere Abmessungen auf Anfrage			

U-Halter Typ N in Edelstahl 1.4162 auf Anfrage

U – Halter Typ N LW 70 t=4mm

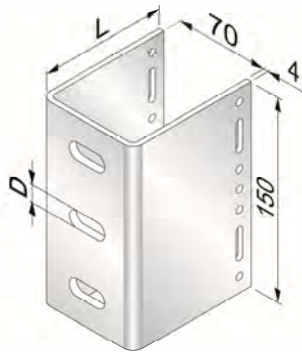

U-Halter Typ N LW 70 H=150mm t=4mm			
Verwendbar als Fest-, Gleit- oder Gleit-/Festpunkt			
Material: EN AW 5754 H24/H34			
Ausladung	Artikel-Nr.		
	Bodenlochung		
L [mm]	D=11mm	D=15mm	
60	061155	065155	
80	081155	085155	
100	101155	105155	
120	121155	125155	
140	141155	145155	
160	161155	165155	
180	181155	185155	
200	201155	205155	
220	221155	225155	
240	241155	245155	
260	261155	265155	
280	281155	285155	
300	301155	305155	
320	321155	325155	
weitere Abmessungen auf Anfrage			

U – Halter Typ N LW 70 t=4mm

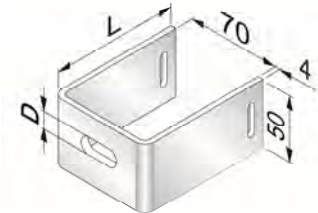

U-Halter Typ N LW 70 H=50mm t=4mm			
Verwendbar als Gleitpunkt			
Material: EN AW 5754 H24/H34			
Ausladung	Artikel-Nr.		
	Bodenlochung		
L [mm]	D=11mm	D=15mm	
60	061055	065055	
80	081055	085055	
100	101055	105055	
120	121055	125055	
140	141055	145055	
160	161055	165055	
180	181055	185055	
200	201055	205055	
220	221055	225055	
240	241055	245055	
260	261066	265055	
280	281055	285055	
300	301055	305055	
320	321055	325055	
weitere Abmessungen auf Anfrage			

U-Halter Typ N in Edelstahl 1.4162 auf Anfrage

U – Halter Typ N LW 70 t=4mm

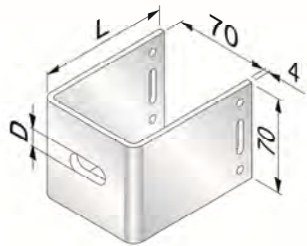

U-Halter Typ N LW 70 H=70mm t=4mm			
Verwendbar als Fest- oder Gleitpunkt			
Material: EN AW 5754 H24/H34			
Ausladung	Artikel-Nr.		
	Bodenlochung		
L [mm]	D=11mm	D=15mm	
60	061075	065075	
80	081075	085075	
100	101075	105075	
120	121075	125075	
140	141075	145075	
160	161075	165075	
180	181075	185075	
200	201075	205075	
220	221075	225075	
240	241075	245075	
260	261075	265075	
280	281075	285075	
300	301075	305075	
320	321075	325075	
weitere Abmessungen auf Anfrage			

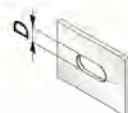
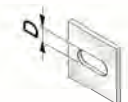

Einlegescheiben			
Material: EN AW 5754 H24/H34			
Abmessungen	Artikel-Nr.		
	D=11mm	D=15mm	
50x50x4	554011	554015	
50x50x5	555011	555015	
70x50x4	754011	754015	
70x50x5	755011	755015	
weitere Abmessungen auf Anfrage			

Thermostop (selbstklebend) für U-Halter



Thermostop für U-Halter H=50mm	
Material: Hart-PVC	
Artikel-Nr.	
055050	

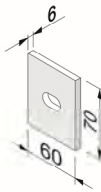

Thermostop für U-Halter H=70mm	
Material: Hart-PVC	
Artikel-Nr.	
055070	



Thermostop für U-Halter H=150mm	
Material: Hart-PVC	
Artikel-Nr.	
055150	

Zubehörteile



BWM Spezialniet SNA 5x12 K14	
Material: Alu-Niro ¹⁾ (grün eloxiert)	
Artikel-Nr.	
051214	
z.B. für U-Halter Typ N LW 50, LW 70, Bolzenprofil	

ATK 601

Befestigungssatz mit T-Konsole

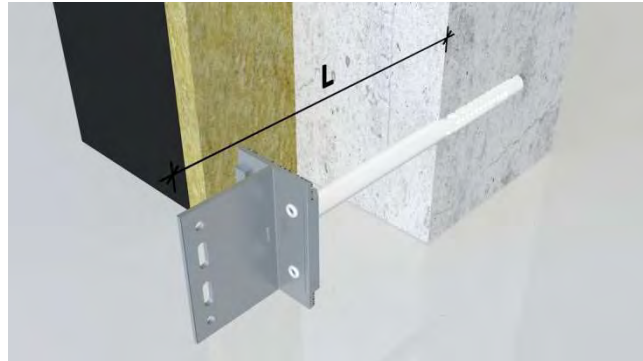

Befestigungssatz ATK 601 , verzinkt				
Set bestehend aus: Grundteil + T-Konsole 60 bzw. T-Konsole 33 14er Dübel und 2 x Verbindungsniete				
Material Dübelschraube : Stahl verzinkt				
L [mm] bei hv*= 70 mm	L [mm] bei hv*= 90mm	Artikel-Nr. T-60	Artikel-Nr. T-33	-----
70	-----	Z-14/ 80	Z33-14/80	
90	70	Z-14/100	Z33-14/100	
110	90	Z-14/120	Z33-14/120	
130	110	Z-14/140	Z33-14/140	
150	130	Z-14/160	Z33-14/160	
170	150	Z-14/180	Z33-14/180	
190	170	Z-14/200	Z33-14/200	
220	200	Z-14/230	Z33-14/230	
250	230	Z-14/260	Z33-14/260	
290	270	Z-14/300	Z33-14/300	
320	300	Z-14/330	Z33-14/330	
350	330	Z-14/360	Z33-14/360	
*hv = Verankerungstiefe Dübel				
weitere Abmessungen auf Anfrage				

Hutprofil 120/30		
Material: EN AW 6063 T66		
L [mm]	Artikel-Nr.	
6000	65118	

ATK 601

Befestigungssatz mit T-Konsole

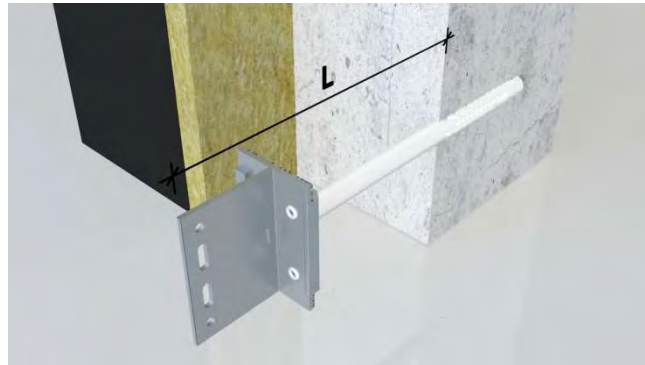

Befestigungssatz ATK 601 , **Edelstahl**

Set bestehend aus:
Grundteil + T-Konsole 60 bzw. T-Konsole 33
14er Dübel und 2 x Verbindungsniete

Material Dübelschraube : Edelstahl A4

L [mm] bei hv*= 70 mm	L [mm] bei hv*= 90mm	Artikel-Nr. T-60	Artikel-Nr. T-33	
70	-----	E-14/ 80	E33-14/ 80	
90	70	E-14/100	E33-14/100	
110	90	E-14/120	E33-14/120	
130	110	E-14/140	E33-14/140	
150	130	E-14/160	E33-14/160	
170	150	E-14/180	E33-14/180	
190	170	E-14/200	E33-14/200	
220	200	E-14/230	E33-14/230	
250	230	E-14/260	E33-14/260	
290	270	E-14/300	E33-14/300	
320	300	E-14/330	E33-14/330	
350	330	E-14/360	E33-14/360	

*hv = Verankerungstiefe Dübel

Preise und Lieferzeit auf Anfrage

Optional: Haltefeder aus Edelstahl

Artikel-Nr.	
20010	

Holzhalter Typ T 2

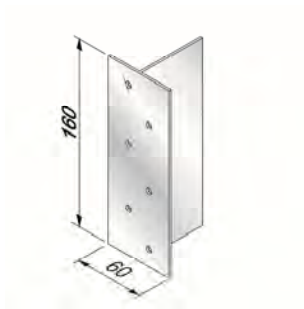

Holzhalter T 2		
Material: EN AW 6063 T66		
L [mm]	Artikel-Nr.	
160	160060	

ATK 103 S und ATK 103 P

Tragprofile ATK 103 S t=2mm



Horizontal-Tragprofil ungelocht t=2mm s=Nennmaß 30mm		
Material: EN AW 6063 T66		
L [mm]	Artikel-Nr.	
6000	668401	



Horizontal-Tragprofil gelocht t=2mm s=Nennmaß 30mm		
Material: EN AW 6063 T66		
L [mm]	Artikel-Nr.	
6000	G68401	

Tragprofile ATK 103 P t=3mm

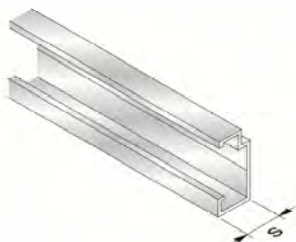

Horizontal-Tragprofil ungelocht t=3mm s=Nennmaß 30mm		
Material: EN AW 6063 T66		
L [mm]	Artikel-Nr.	
6000	668402	



Horizontal-Tragprofil gelocht t=3mm s=Nennmaß 30mm		
Material: EN AW 6063 T66		
L [mm]	Artikel-Nr.	
6000	G68402	

ATK 103 S Agraffen t=3mm

Agraffen t=2mm						
Material: EN AW 6063 T66						
		z.B. für	FZP/M6	FZP/M8	Durchsteck-Montage	Lithodecor
Breite [mm]			D=6,5mm	D=9mm	6-kant (mit Zellgummi)	D=6,5mm (mit Zellgummi)
36	justierbar	Art.-Nr.	68236	68239	68632	68633
	starr	Art.-Nr.	68136	68139	68532	68533
60	justierbar	Art.-Nr.	68260	68269	68662	68663
	starr	Art.-Nr.	68160	68169	68562	68563
80	justierbar	Art.-Nr.	68280	68289	68682	68683
	starr	Art.-Nr.	68180	68189	68582	68583
Sonderbreiten: auf Anfrage					Agraffen ohne Zellgummi auf Anfrage	
Justierbare Agraffen incl. Stellschraube und Teile zur Plattenfixierung						

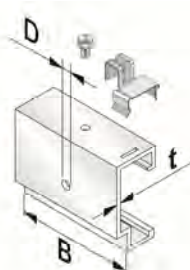
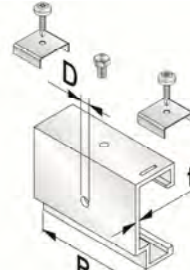
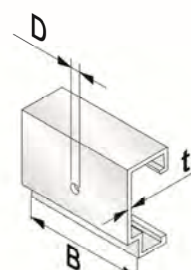
Agraffen justierbar		Agraffen starr
Variante 1 mit Fixierklammer - (bei Bestellung bitte angeben)	Variante 2 mit seitlich anzuordnenden U-Profilstücken (wird als Standard mitgeliefert)	
		
Fixierklammer nur für Platten < 60x90 cm und Gewicht < 30 kg/m ²		

Preisliste ATK 103 P

Agraffen t=3mm

Agraffen t=3mm							
Material: EN AW 6063 T66							
		z.B. für	FZP/M6	FZP/M8	Eternit	Keil	Lithodecor
Breite [mm]			D=6,5mm	D=9mm	4-kant	6-kant (mit Zellgummi)	D=6,5mm (mit Zellgummi)
36	justierbar	Art.-Nr.	68436	68439	68736	68636	68737
36	starr	Art.-Nr.	68336	68339	68836	68536	68837
60	justierbar	Art.-Nr.	68460	68469	68760	68660	68761
60	starr	Art.-Nr.	68360	68369	68860	68560	68861
80	justierbar	Art.-Nr.	68480	68489	68880*	68680	68881
80	starr	Art.-Nr.	68380	68389	68780*	68580	68781
Sonderbreiten: auf Anfrage				* Standard = 2-fach Lochung. 1-fach Lochung auf Anfrage		Agraffen ohne Zellgummi auf Anfrage	
Justierbare Agraffen incl. Stellschraube und Teile zur Plattenfixierung							

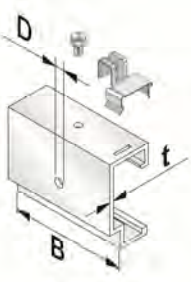
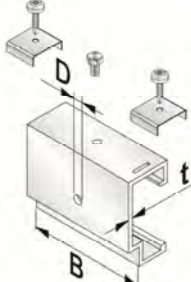
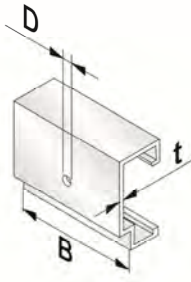
Agraffen justierbar		Agraffen starr
Variante 1 mit Fixierklammer - (bei Bestellung bitte angeben)	Variante 2 mit seitlich anzuordnenden U-Profilstücken (wird als Standard mitgeliefert)	
		
Fixierklammer nur für Platten < 60x90 cm und Gewicht < 30 kg/m ²		

ATK 103 T

Tragprofile

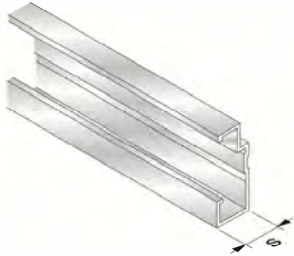

Horizontal-Tragprofil ungelocht t=3mm s=Nennmaß 30mm

Material: EN AW 6063 T66

L [mm]	Artikel-Nr.	
6000	668430	

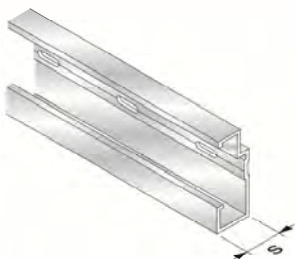

Horizontal-Tragprofil gelocht t=3mm s=Nennmaß 30mm

Material: EN AW 6063 T66

L [mm]	Artikel-Nr.	
6000	G68430	

Agraffen

Agraffen justierbar t=3mm

Material: EN AW 6063 T66

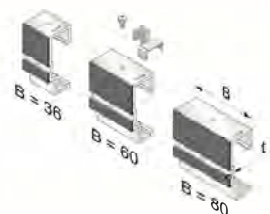

B [mm]	Artikel-Nr.	
36	68031	
60	68032	
80	68033	
mit Stellschraube und Teile zur Plattenfixierung		

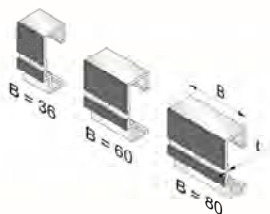

Agraffen starr t=3mm

Material: EN AW 6063 T66

B [mm]	Artikel-Nr.	
36	68034	
60	68035	
80	68036	

ATK 103 S-20 und ATK 103 P-20

Tragprofil ATK S-20 t=2mm



Horizontal-Tragprofil ungelocht t=2mm s=Nennmaß 20mm		
Material: EN AW 6063 T66		
L [mm]	Artikel-Nr.	
6000	668422	

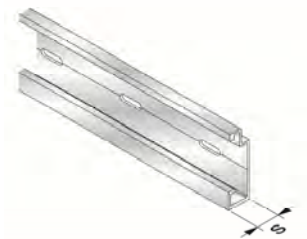

Horizontal-Tragprofil gelocht t=2mm s=Nennmaß 20mm		
Material: EN AW 6063 T66		
L [mm]	Artikel-Nr.	
6000	G68422	

Tragprofile ATK 103 P-20 t=3mm

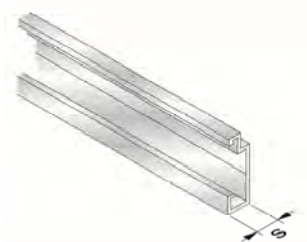

Horizontal-Tragprofil ungelocht t=3mm s=Nennmaß 20mm		
Material: EN AW 6063 T66		
L [mm]	Artikel-Nr.	
6000	668420	



Horizontal-Tragprofil gelocht t=3mm s=Nennmaß 20mm		
Material: EN AW 6063 T66		
L [mm]	Artikel-Nr.	
6000	G68420	

ATK 103 S 20
Agraffen t=2mm

Agraffen t=2mm						
Material: EN AW 6063 T66						
		z.B. für	FZP/M6	FZP/M8	Durchsteck-Montage	Lithodecor
Breite [mm]			D=6,5mm	D=9mm	6-kant (mit Zellgummi)	D=6,5mm (mit Zellgummi)
36	justierbar	Art.-Nr.	28236	28239	28632	28633
36	starr	Art.-Nr.	28136	28139	28532	28533
60	justierbar	Art.-Nr.	28260	28269	28662	28663
60	starr	Art.-Nr.	28160	28169	28562	28563
80	justierbar	Art.-Nr.	28280	28289	28682	28683
80	starr	Art.-Nr.	28180	28189	28582	28583
Sonderbreiten: auf Anfrage					Agraffen ohne Zellgummi auf Anfrage	
Justierbare Agraffen incl. Stellschraube und Teile zur Plattenfixierung						

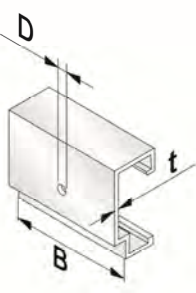
Agraffen justierbar	Agraffen starr
mit seitlich anzuordnenden U-Profilstücken (wird als Standard mitgeliefert)	
	

ATK 103 P 20 Agraffen t=3mm

Agraffen t=3mm							
Material: EN AW 6063 T66							
		z.B. für	FZP/M6	FZP/M8	Eternit	Keil	Lithodecor
Breite [mm]			D=6,5mm	D=9mm	4-kant	6-kant (mit Zellgummi)	D=6,5mm (mit Zellgummi)
36	justierbar	Art.-Nr.	28436	28439	28736	28636	28737
	starr	Art.-Nr.	28336	28339	28836	28536	28837
60	justierbar	Art.-Nr.	28460	28469	28760	28660	28761
	starr	Art.-Nr.	28360	28369	28860	28560	28861
80	justierbar	Art.-Nr.	28480	28489	28780*	28680	28781
	starr	Art.-Nr.	28380	28389	28880*	28580	28881
Sonderbreiten: auf Anfrage			* Standard = 2-fach Lochung. 1-fach Lochung auf Anfrage			Agraffen ohne Zellgummi auf Anfrage	
Justierbare Agraffen incl. Stellschraube und Teile zur Plattenfixierung							

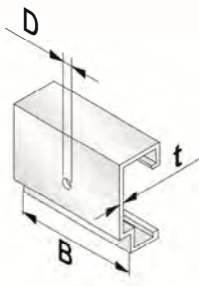
Agraffen justierbar	Agraffen starr
mit seitlich anzuordnenden U-Profilstücken (wird als Standard mitgeliefert)	
	

Agraffen ATK 103 EE

Agraffen ATK 103 EE für erleichterten Einbau

Agraffen EE passend zu Tragprofilen ATK 103 P + S					
Material: EN AW 6063 T66					
Breite [mm]			D=7,0mm (mit Zellgummi)	D=8,5mm (mit Zellgummi)	D=7,0mm (ohne Zellgummi)
36	justierbar	Art.-Nr.	23231	23271	23221
36	starr	Art.-Nr.	23232	23272	23222
60	justierbar	Art.-Nr.	23233	23273	23223
60	starr	Art.-Nr.	23234	23274	23224
80	justierbar	Art.-Nr.	23235	23275	23225
80	starr	Art.-Nr.	23236	23276	23226
Sonderbreiten und Lochungen auf Anfrage					
Justierbare Agraffen incl. Stellschraube M 8 x 14 und Teile zur Plattenfixierung (U-Profilstücke LW 11 + Bohrschraube)					

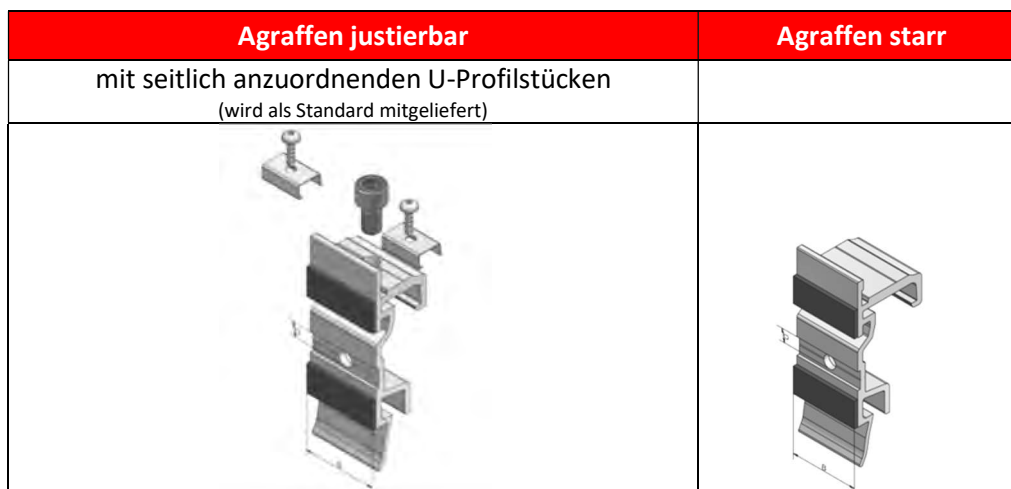

Agraffen ATK 103 EE 20

Agraffen ATK 103 EE 20 für erleichterten Einbau

Agraffen EE 20 passend zu Tragprofilen ATK 103 P 20 + S 20					
Material: EN AW 6063 T66					
Breite [mm]			D=7,0mm (mit Zellgummi)	D=8,5mm (mit Zellgummi)	D=7,0mm (ohne Zellgummi)
36	justierbar	Art.-Nr.	23211	23251	23201
	starr	Art.-Nr.	23212	23252	23202
60	justierbar	Art.-Nr.	23213	23253	23203
	starr	Art.-Nr.	23214	23254	23204
80	justierbar	Art.-Nr.	23215	23255	23205
	starr	Art.-Nr.	23216	23256	23206
Sonderbreiten und Lochungen auf Anfrage					
Justierbare Agraffen incl. Stellschraube M 8 x 14 und Teile zur Plattenfixierung(U-Profilstücke LW 11 + Bohrschraube)					

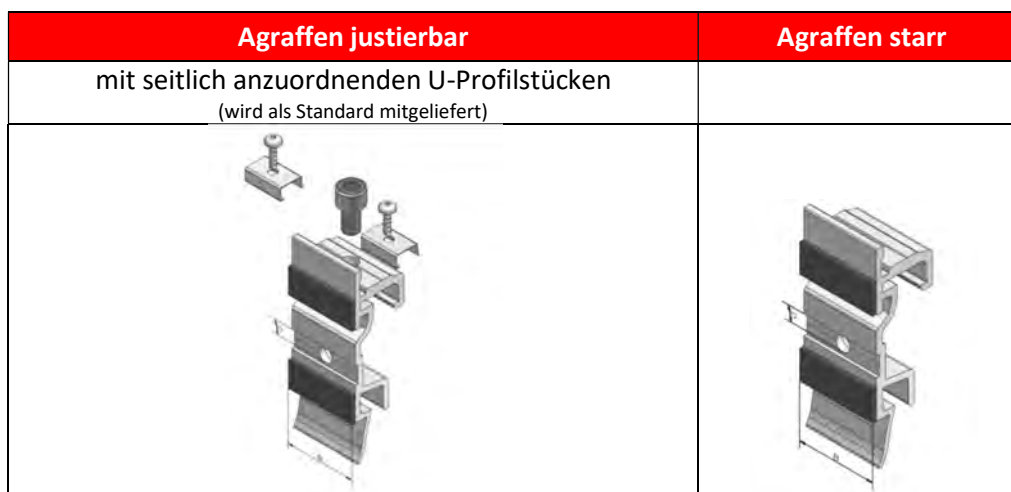

ATK 103 V, V-1 und Z Tragprofil ATK 103 V

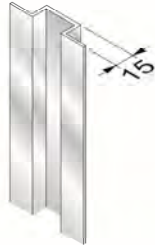

Hutprofil 65/30/15 mm		
Material: EN AW 6063 T66		
L [mm]	Artikel-Nr.	
6000	668004	
Fixlängen sowie Boden-/Schenkelbohrung auf Anfrage		

Tragprofil ATK 103 V - 1

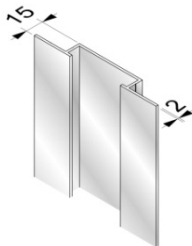

Hutprofil 116/60/15 mm		
Material: EN AW 6063 T66		
L [mm]	Artikel-Nr.	
6000	668005	
Einschubprofil andere Längen auf Anfrage		

Tragprofil ATK 103 Z

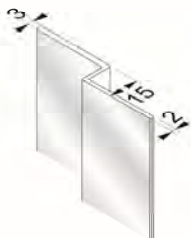

Z-Profil 40/15/40 mm		
Material: EN AW 6063 T66		
L [mm]	Artikel-Nr.	
6000	668006	
Fixlängen sowie Schenkelbohrung auf Anfrage		

ATK 103 S-20 T

Tragprofile und Agraffen ATK 103 S-20 T



Horizontal-Tragprofil ungelocht H=76mm t=2mm s=Nennmaß 20mm		
Material: EN AW 6063 T66		
L [mm]	Artikel-Nr.	
6000	668440	

Agraffen t=2mm						
Material: EN AW 6063 T66						
		z.B. für	FZP/M6	FZP/M8	Durchsteck- Montage	Durchsteck- Montage
Breite [mm]			D=6,5mm	D=9mm	6-kant (mit Zellgummi)	D=6,5mm (mit Zellgummi)
36	justier- bar	Art.-Nr.	18236	18239	18632	18633
	starr	Art.-Nr.	18136	18139	18532	18533
60	justier- bar	Art.-Nr.	18260	18269	18662	18663
	starr	Art.-Nr.	18160	18169	18562	18563
80	justier- bar	Art.-Nr.	18280	18289	18682	18683
	starr	Art.-Nr.	18180	18189	18582	18583
Sonderbreiten und Agraffen ohne Zellgummi erhältlich auf Anfrage						
Justierbare Agraffen incl. Stellschraube und Teilen zur Plattenfixierung						

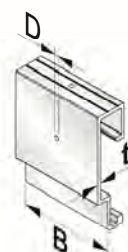
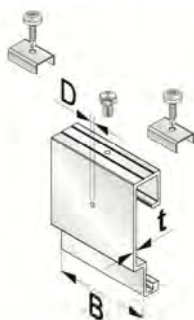

BWM - Brandbarrieren



Lüftungsprofil t=1mm		
Material: Galvalume		
L [mm)	Artikel-Nr.	
3000	500001	
Andere Abmessungen auf Anfrage		



Befestigungslasche für Lüftungsprofil t=1,5mm	
Material: Galvalume	
Artikel-Nr.	
500002	

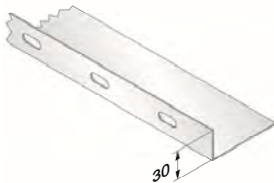

Wandprofil L = 3000 mm t=1mm		
Material: Galvalume		
Abmessungen	Artikel-Nr.	
30 mm x 40 mm	500010	
30 mm x 70 mm	500011	
30 mm x 100 mm	500012	
30 mm x 130 mm	500013	
30 mm x 160 mm	500014	
30 mm x 190 mm	500015	
30 mm x 220 mm	500016	
30 mm x 250 mm	500017	
30 mm x 280 mm	500018	
30 mm x 310 mm	500019	
30 mm x 340 mm	500020	
30 mm x 370 mm	500021	



Spezialniet 4x8 Niro-Niro		
Material: Niro-Niro ¹⁾		
Farbe	Artikel-Nr.	
blank	330444	
zur Verbindung der Befestigungslasche und des Lüftungsprofils auf dem Wandprofil		

AccuBird und Nietsetzlehren



Gesipa AccuBird		
im Stahlblechkoffer incl. Akku und Schnellladegerät		
Bezeichnung	Artikel-Nr.	
Accu-Bird	7250037	
Schnellwechselakku	7251045	
Schnellladegerät	7251134	
weitere Geräte/Zubehör auf Anfrage		



Nietsetzlehren SL 20	
für SNA 3,2 x 8 N-N mit langem Dorn	
Artikel-Nr.	
7259352	
z.B. zur Befestigung Klammer ATK 100 KL am Tragprofil	



Nietsetzlehre	
für SNA 5 x 12 K14	
Artikel-Nr.	
501217	
z.B. zur Befestigung Wandwinkel/U-Halter Typ N auf Tragprofil	



**Sagen Sie uns Ihre Wünsche,
Ihre Probleme: Wir zeigen Ihnen
eine technisch ausgereifte,
wirtschaftliche Lösung auf
hohem, qualitativem Niveau.
Dafür garantieren auch unsere
Mitgliedschaften im FVHF und DGNB.**



**BWM
Fassadensysteme
GmbH**

Ernst-Mey-Straße 1
D-70771
Leinfelden-Echterdingen

T +49 (0) 711 / 90 313-0
F +49 (0) 711 / 90 313-20
info@bwm.de | www.bwm.de